

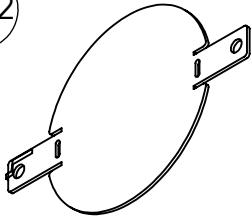

<p>ST12</p>  <p>Ø 60 mm</p> <p>2x</p>	<p>ST54</p>  <p>Ø 60x1020mm</p> <p>2x</p>	<p>G10</p>  <p>Ø 40 mm</p> <p>2x</p>
<p>G11</p>  <p>Ø 15 x 50 mm</p> <p>2x</p>	<p>G13</p>  <p>Ø 6x1x1000mm</p> <p>5x</p>	<p>G17</p>  <p>Ø 40x320mm</p> <p>3x</p>
<p>GS19</p>  <p>Ø 22x1,65x978mm</p> <p>3x</p>	<p>D01</p>  <p>Ø 12 mm</p> <p>6x</p>	<p>D02</p>  <p>Ø 8 mm</p> <p>3x</p>
<p>NT11</p>  <p>Ø 4 x 25mm</p> <p>16x</p>	<p>NT19</p>  <p>M8 x 60mm</p> <p>6x</p>	<p>NT26</p>  <p>M8 DIN125</p> <p>6x</p>
<p>NT48</p>  <p>M6</p> <p>3x</p>	<p>NT49</p>  <p>M6</p> <p>3x</p>	<p>5x</p> 

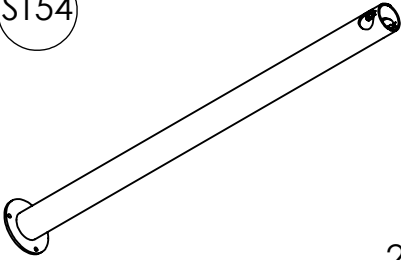

3

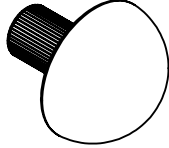
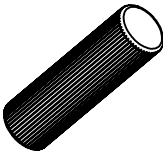
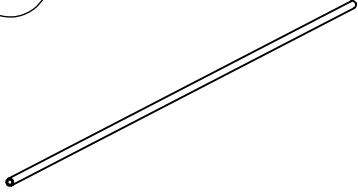
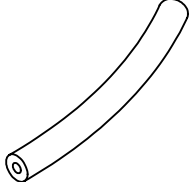
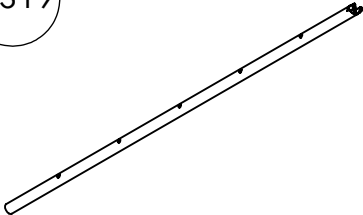
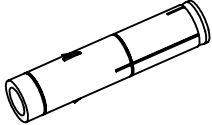
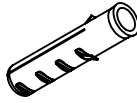
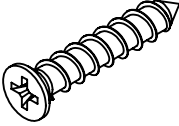
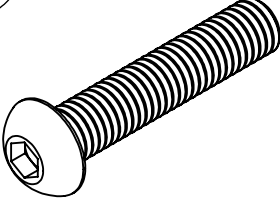
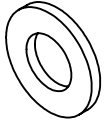

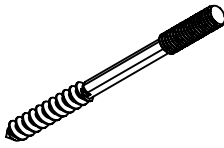
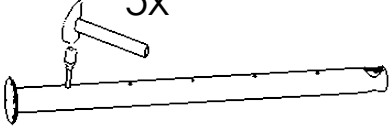
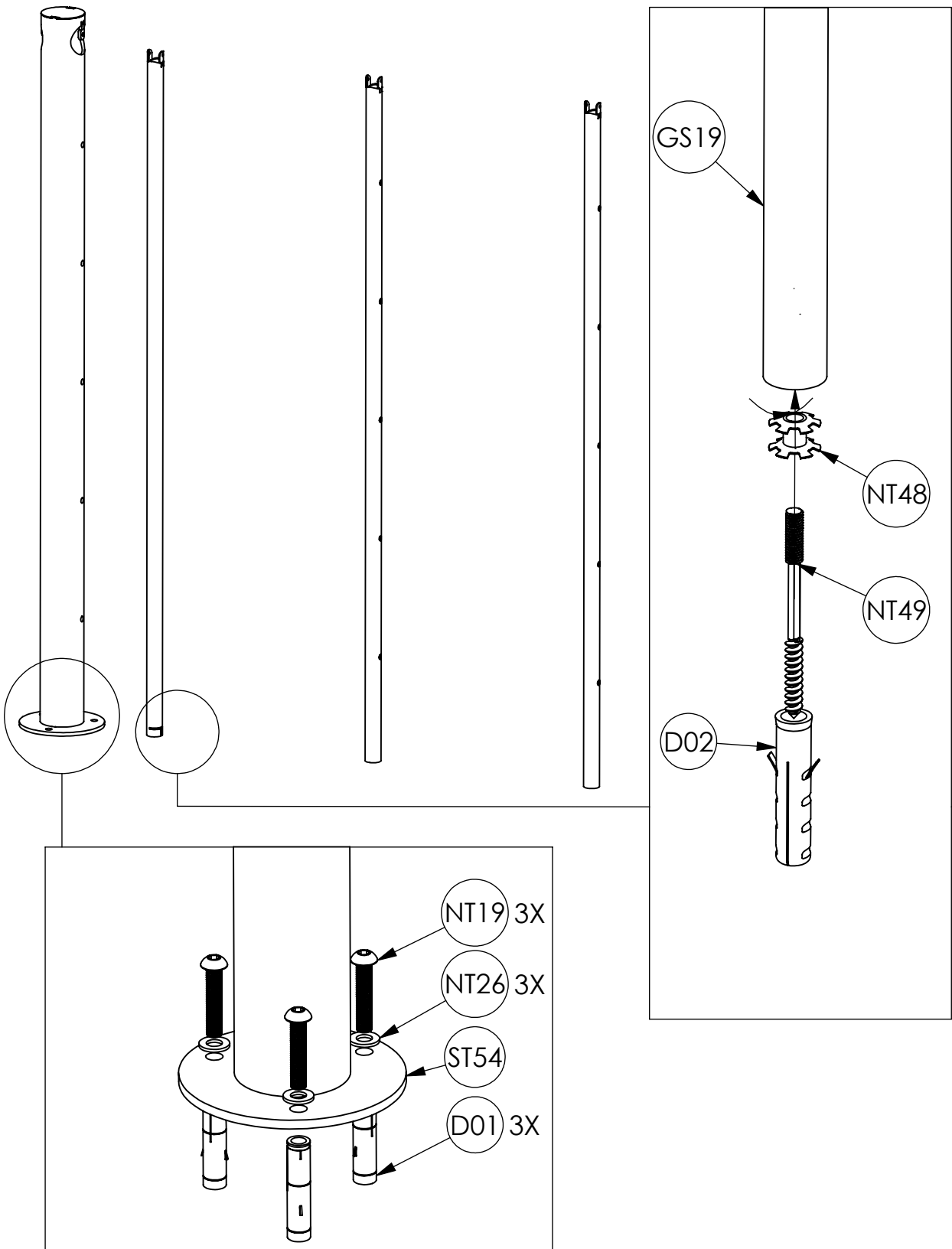
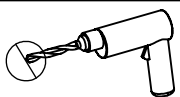
12 mm

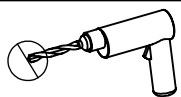

6 mm

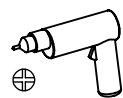

⊕

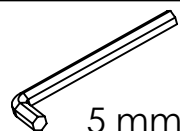

5 mm

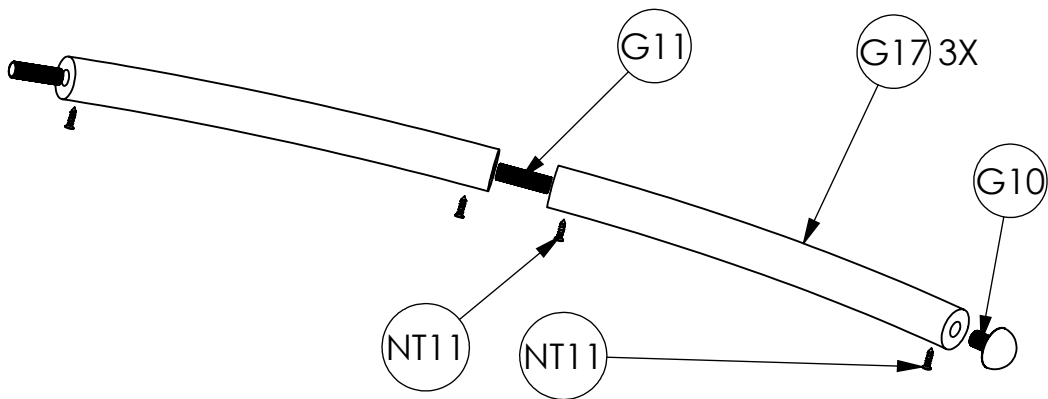
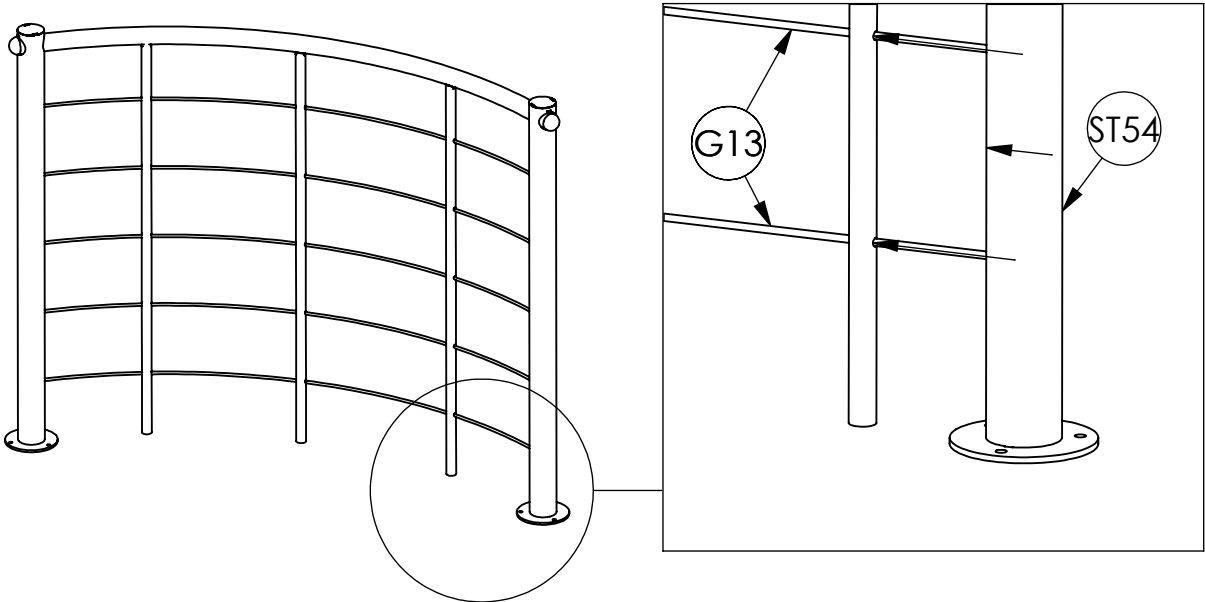
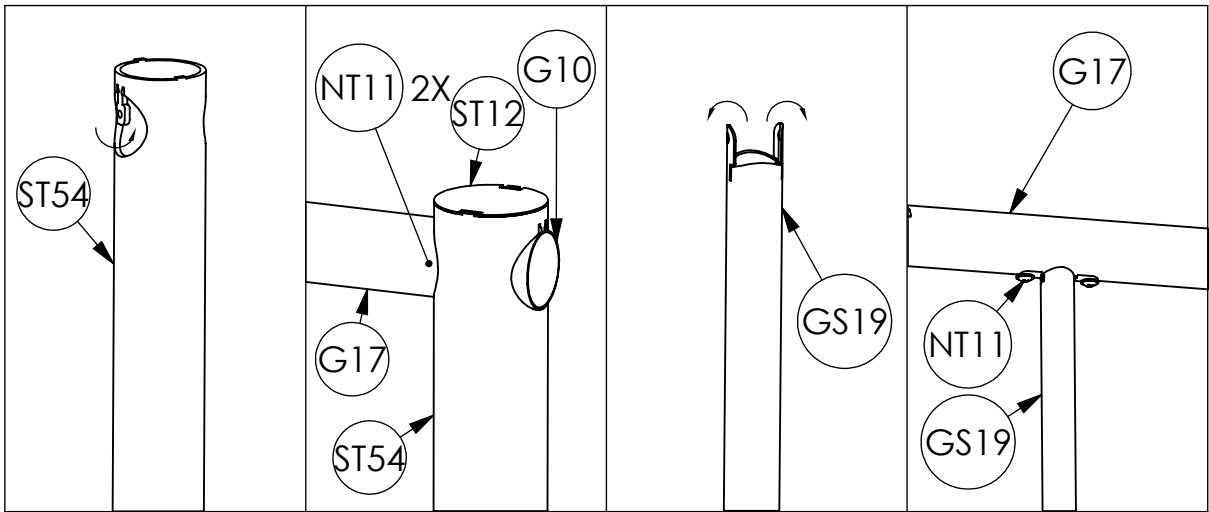

4



12 mm